



REQUEST FOR PROPOSAL
For
Pikes Peak Library District – East Library
Asphalt Remove and Replace

PIKES PEAK LIBRARY DISTRICT
Colorado Springs, CO

RFP # 490-24-01-EA

The Pikes Peak Library District (PPLD) invites contractors, with the qualifications as stated herein, to submit a response to a Request for Proposal (RFP) for the East Library, 5550 N. Union Blvd, for asphalt removal and replacement.

Proposal deadline is **2 p.m. MST on Monday April 8, 2024.**

Table of Contents

1. Terms & Condition.....2

2. Proposal Submission, Selection, and Contract Formation..... 4

3. Scope of Work ..... 7

4. Contractor Qualification and Information..... 7

5. Pricing 8

ADDENDUM A - PROPOSAL COVER SHEET 9

ADDENDUM B - CHECKLIST, QUESTIONNAIRE, AND PRICING FORM 11

ADDENDUM C - IMMIGRATION CLAUSE FOR CONTRACTS 12

1. Terms & Condition

- 1.1. Purpose: PPLD is seeking proposals from qualified contractors experienced in asphalt replacement for the East Library. Contractors must be able to certify they have the capabilities and resources to provide all services outlined in the statement of work for this project.
- 1.2. Interested Parties: All interested contractors that have the qualifications as stated herein are invited to submit a proposal in accordance with the terms, conditions, and specifications contained herein, provided by Ground Engineering. An electronic version of this document can be accessed at: <http://ppld.org/request-for-proposals>.
- 1.3. Point of Contact: Questions and requests for clarification must be sent via e-mail to Travis Keeton, Facilities Project Manager, at tkeeton@ppld.org; CC: khoggatt@ppld.org & gsyling@ppld.org. Please include the RFP number, title, and words “question” and/or “clarification” in the subject line of the e-mail.

Questions and requests without this subject identification may be considered routine emails and may not be promptly addressed.

All answers to questions and requests for clarification will be posted on the PPLD website: <http://ppld.org/request-for-proposals> .

Any PPLD response that is considered to be a change in terms, conditions, and specifications of this RFP will be published as an addendum. No communications of any kind may be considered as a change to the terms, conditions, and specifications in this RFP unless posted as a formal addendum on the link above.
- 1.4. Equal Opportunity: The Contractor agrees not to refuse to hire, discharge, promote, or demote, nor to discriminate in matters of compensation against any person otherwise qualified, solely because of race, color, religion, national origin, gender, age, military status, sexual orientation, marital status, or physical or mental disability.
- 1.5. Expenses: PPLD assumes no liability for payment of expenses incurred by proposers in the preparation and submission of proposals in response to this invitation.
- 1.6. Conflict of Interest: Any contractual relationship with any PPLD personnel in the twelve (12) months preceding the distribution of this RFP, or any similar or potential conflicts of interest, may, at the sole discretion of PPLD, be grounds for rejection of the proposal and/or termination of any contract awarded
- 1.7. Independent Contractor: The Contractor is an independent contractor. Notwithstanding any provision appearing in this RFP, all personnel assigned by the Contractor to perform work under the terms of this RFP and any subsequent agreement shall be, and remain at all times, employees or agents of the Contractor for all purposes. The Contractor shall make no representation that it is the employee of PPLD for any purpose.
- 1.8. Immigration Clause: The Contractor is aware of Colorado’s Immigration /Illegal alien laws pertaining to public contracts. Addendum C - Immigration Clause for Contracts (Colorado Statute 8-17.5-102) must be signed and attached.
- 1.9. General Requirements: PPLD reserves the right to amend this RFP up to seven (7) business days prior to the date set for receipt of proposals. In addition, PPLD may extend deadlines or withdraw this RFP at any time prior to an award.
- 1.10. Tax Exemption: PPLD, as a local government entity, is **exempt from sales and use taxes**. Contractors will inform all prospective sub-contractors and suppliers, as necessary, from whom they expect to obtain services or supplies of the tax-exempt status of PPLD. Following the contract award, PPLD will furnish tax exemption certificate(s) to the Contractor.
- 1.11. Governing Law: The laws of the State of Colorado shall govern any contract executed between the successful proposer and PPLD. Further, the place of performance and transaction of business shall be

deemed to be in the County of El Paso, State of Colorado, and in the event of litigation, the exclusive venue and place of jurisdiction shall be the State of Colorado, and more specifically, El Paso County, Colorado.

1.12. RFP Schedule:

RFP released..... Monday March 11, 2024
Mandatory Pre-bid Conference..... Friday March 22, 2024 at 12-1 East Library
Deadline for final questions..... Wednesday March 27, 2024 at 2 p.m.
Deadline to return answered questions Wednesday April 3, 2024 at 2 p.m.
Proposals due..... Monday April 8, 2024 at 2 p.m.
Board Review and Decision Wednesday May 15, 2024 at 5 p.m.
Award Notification..... On or before Friday May 17.

2. Proposal Submission, Selection, and Contract Formation

2.1. Proposal Submission

2.1.1. Substantive proposals: By submitting a proposal, the proposer guarantees that (a) its proposal is genuine and is not made in the interest of, or on behalf of, any undisclosed person, Contractor, or corporation; (b) it has not directly or indirectly induced or solicited any other respondent to put in a false or sham bid; (c) it has not solicited or induced any other person, Contractor, or corporation from proposing; (d) it has not sought by collusion to obtain for itself any advantage over any other proposer or over PPLD.

2.1.2. Submission Information and Documents: The proposal must be comprehensive and address all RFP requirements. To assure that the information provided can be readily identified, the proposal must include, but not limited to, the submission of the following signed documents:

2.1.2.1. Addendum A - PROPOSAL COVER SHEET

2.1.2.2. Addendum B - CHECKLIST, QUESTIONNAIRE, AND PRICING

Contractor is required to submit a response for each numbered or lettered item of Addendum B, the response must be in the same format and sequence as in the RFP. The response must include description, schedules, when required, and any additional clarifying information, such as appendices, charts, diagrams, etc..

2.1.2.3. Addendum C – IMMIGRATION CLAUSE FOR CONTRACTS

2.1.2.4. List of exceptions or deviations (if any)

2.1.2.5. Exhibit 1 – Site Drawings

2.1.2.6. Exhibit 2 – Drain Specifications

2.1.2.7. Exhibit 3 – Combined Bid Schedule

2.1.3. Signatures: The proposal must be signed by an officer of the proposing Contractor.

2.1.4. Exceptions and Deviations: Any exception to or deviations from these Terms & Conditions must be identified, in writing, on an attachment to the proposal submission. PPLD reserves the right to accept or reject, at its sole discretion, any exceptions or deviations by the proposer.

2.1.5. Integration with Contract: The winning proposal will be included and integrated into the final contract documents.

2.1.6. Proposal Submission: Proposals are to be submitted electronically or in sealed envelopes, identified with the proposal number and title with all attachments. See the Schedule of Events for due dates. Contractors must submit three (3) hard copies and (1) soft copy (i.e., flash drive, magnetic media, etc.) of the Proposal to:

Pikes Peak Library District
Attn: Kim Hoggatt
Finance Office
RFP # 490-24-01-EA
1175 Chapel Hills Drive,
Colorado Springs, CO, 80920

Additional copies may be requested by Pikes Peak Library District. Pikes Peak Library District is not liable for any cost incurred by prospective respondents prior to the issuance of contract(s).

The deadline (Contractor) is Monday April 8, 2024 **no later than 2 p.m.** local time. Proposals delivered after that time will be received but will be rejected for being late.

A complete submission includes all required components, as stated in this document.

There will be no public bid opening for this RFP.

2.1.7. Duration of Proposal Offer: Price offers are irrevocable for 90 days following the proposal due date. Once a proposal is accepted, all prices, terms and conditions will remain unchanged throughout the contract period unless specifically agreed otherwise by both PPLD and the successful Contractor through documented change orders.

2.1.8. Withdrawal of Proposal: A Proposer may withdraw its own proposal at any time prior to the proposal due date and time as identified herein. After that date and time, no proposal may withdraw its proposal for any reason. All proposals shall be valid for a period not less than 90 calendar days after the proposal due date.

2.1.9. Information to Contractors:

2.1.9.1. No proposal shall be accepted from, and no contract will be awarded to any person, Contractor or corporation that is deemed irresponsible or unreliable by PPLD. If requested, Contractors will submit satisfactory evidence that they have a practical knowledge of the service bid upon and that they have the necessary financial resources to provide the proposed service called for as described in this Request for Proposal.

2.1.9.2. PPLD reserves the right to investigate the Contractor’s financial stability. This may include reviewing financial statements, checking bank reference, and interviewing past contractors, employees, and creditors. Unfavorable responses to these investigations are grounds for rejection of the proposal.

2.1.10. Confidentiality: All materials submitted in response to this RFP become the property of PPLD, upon delivery.

Proposals are public information. If a contractor submits proprietary information, the contractor will label each proprietary page as “CONFIDENTIAL” and submit it in a separate package so PPLD will not release any information marked as Confidential.

2.1.11. Subcontracting: The Contractor must be responsible for the performance of all of its sub-contractors, and consultants. The use of specific subcontractors and consultants is subject to the approval of PPLD. The Contractor is responsible for ensuring that all sub-contractors and consultants comply with all the terms of the Contractor’s contract with PPLD.

If the Contractor uses subsidiary companies, explain their role and how they will be involved in this project.

2.1.12. Insurance Requirements: The successful proposer shall have, at the minimum, the following coverage: commercial general liability, automobile liability, excess liability, and worker’s compensation liability. The Contractor shall submit in their proposals, ACORD certificates and/or other proof of the following insurances:

2.1.12.1.	General Liability	\$1,000,000
2.1.12.2.	Automobile Liability	\$1,000,000
2.1.12.3.	Excess (umbrella) Liability	\$1,000,000
2.1.12.4.	Per Truck	\$100,000
2.1.12.5.	Per Occurrence	\$1,000,000
2.1.12.6.	Worker’s Compensation liability that meets statutory requirements.	

2.1.13. Indemnification: The proposer agrees to, and shall, defend, release, and indemnify, and save and hold harmless PPLD, its officer, agents, and employees from and against any and all damages to property or injuries to or death of any person or persons, including property and officers, employees, and agents of PPLD, and further agrees to, and shall, defend, indemnify, and save and hold harmless PPLD, its officers, agents, and employees, from and against any and all claims, costs, demands, liabilities, suits, actions, causes of action, and other legal or equitable proceedings of any kind or nature whatsoever, of or by anyone whomsoever, including, but not limited to claims arising out of and/or predicated upon negligence, breach of contract, tort, or strict liability, in any way resulting from, connected with, or arising out of the Contractor’s operations or performance in connection herewith, including operations or performance of sub-contractors and suppliers and acts or omissions of officers, employees, or agents of the Contractor or its sub-contractors or suppliers.

2.1.14. Schedule: By submitting a proposal, the proposer guarantees that it will be able to comply with the agreed upon, overall schedule.

2.1.14.1. Anticipated sitework for this proposal to be completed in August-September 2024.

2.1.15. Continuity: By submitting a proposal, the proposer will make its best efforts to ensure that the key team member(s) remain assigned to the PPLD’s project for the duration of contract. Any changes to the staffing of this engagement must be discussed up front with PPLD personnel.

2.2. Selection

2.2.1. Right of Acceptance and Rejection: PPLD reserves the right to accept or reject any or all proposals and to waive any formalities, informalities, and deviations, which, in its opinion, best serve the interests of PPLD. PPLD is not bound to accept the lowest price proposal.

2.2.2. Selection: It is the intent of PPLD to select only responsible and responsive Contractors. Bidder’s proposal should include the most favorable terms and conditions.

2.2.3. Negotiation: PPLD reserves the right to negotiate terms and conditions of the contract with the winning Contractor.

2.2.4. Basis of Award: An evaluation team will judge the merit of proposals received in accordance with the general criteria defined within this RFP. The recommendations of this team will be forwarded to the Board of Trustees for approval and execution. The following criteria will be taken into consideration when making evaluations of proposals. This list is not intended to be exhaustive nor ranking in order of importance:

2.2.4.1. Completeness of Proposal

2.2.4.2. References

2.2.4.3. Pricing

2.2.4.4. Quality of Services

2.2.4.5. Contractor Qualifications and History

2.2.4.6. Any other items deemed in the best interests of PPLD

2.3. Contract Formation

2.3.1. Agreement in Writing: Following selection of a proposal, the Contractor will be required to enter into a written contract with PPLD. American Institute of Architects (AIA) Contract A110 Owner and Contractor is preferred.

The winning Bidder’s RFP proposal will be included and integrated into the final contract documents. It is in the Bidder’s best interest to ensure the proposal is accurate to allow for the integration with minimal changes.

If you have a formal or standard contract that you typically use with such projects, please attach a copy to your Proposal. A Service Agreement is not a condition of accepting an RFP.

If, in PPLD’s sole discretion, the selected proposer has not executed the contract documents within a reasonable time after selection, PPLD reserves the right to rescind the award and select another Contractor.

2.3.2. Amendments to Contract: Parties hereto reserve the right to make amendments or modifications to the contract by written amendment signed by both parties.

2.3.3. Termination of Contract for Cause: If, through any cause, the successful Bidder shall fail to fulfill in a timely and proper manner its obligations or if the successful Bidder shall violate any of the covenants, agreements, or stipulations of the Contract, PPLD shall thereupon have the right to terminate the Contract by giving written notice to the successful Bidder of such termination and specifying the effective date of termination. In that event, all finished or unfinished services, reports or other materials prepared by the successful Bidder shall, at the option of PPLD, become its property, and the successful Bidder shall be

entitled to receive just, equitable compensation for any satisfactory work completed, prepared documents or materials as furnished. Notwithstanding the above, the successful Bidder shall not be relieved of liability to PPLD for damage sustained by PPLD by virtue of breach of the Contract by the successful Bidder and PPLD may withhold any payments to the successful Contractor for the purpose of set offer until such time as the exact amount of damages due PPLD from the successful Bidder is determined.

2.3.4. Termination of Contract for Convenience: PPLD may terminate the Contract at any time by giving written notice to the successful Contractor of such termination and specifying the effective date thereof, at least thirty (30) working days before the effective date of such termination. In that event, all finished or unfinished services, reports, material(s) prepared or furnished by the successful Bidder under the Contract shall, at the option of PPLD, become its property.

2.3.5. Cancellation: Either party may cancel the Contract in the event that a petition, either voluntary or involuntary, is filed to declare the other party bankrupt or insolvent or in the event that such party makes an assignment for the benefit of creditors.

3. Scope of Work

3.1. Service Specifications:

3.1.1. The specifications of this project were created by Ground Engineering.

3.1.1.1. Z535 Drain Specifications

3.1.1.2. Combined Bid Schedule

3.1.1.3. Pavement Thickness

3.1.1.4. Mill Depth

3.1.1.5. Concrete Specifications

3.1.1.6. Phasing approach

3.1.1.7. General Guidelines

3.1.2. Contractor shall take into consideration all water run off and include a stormwater management plan for the duration of the project.

3.2. Awarded contractor shall return the parking lot to its current status including, parking stalls, striping, signs etc.

3.3. Awarded contractor shall coordinate schedules with Facilities Project Manager.

3.4. All work shall be done to the highest of industry quality and be in general accordance with Pikes Peak Rural Transportation Authority and/or City of Colorado Springs standards for roadway construction.

3.5. Ground Engineering, representing PPLD, will conduct quality assurance inspections and testing of all materials specified in the completion of this work at no cost to the contractor. Any and all defaults found shall be the responsibility of the awarded contractor for correction.

3.6. The successful proposer shall be required to furnish all permits, equipment, tools, machinery, transportation, and other implements necessary to fulfill the provisions of this Contract. This includes but is not limited to all procurement and contracting requirement specifications included within.

3.7. Environmental risks are to be addressed throughout the project. The use of safety cones, caution tape, rock socks, traffic control, traffic control permits,

3.8. No non-employees, employee's significant others, employee's children, or employee's pet(s) shall be permitted on the jobsite, by the Contractor or any others, during the performance of this contract.

4. **Contractor Qualification and Information**

The following information and documents must be included in submitted proposal:

4.1. Provide the name of the proposing Contractors, address, telephone and primary contact person.

- 4.2. State the size of the Contractor and provide a history summary.
- 4.3. Your organization's qualifications and experience. If you have experience with PPLD Libraries, describe your current or past relationship. Describe any similar projects performed by your organization.
- 4.4. Provide references from minimum three (3) recent similar projects including name, telephone number and a brief statement describing their association with your Contractor (e.g., other library, educational or public sector clients). References from Colorado are preferred.
- 4.5. Provide resumes of the certified team members that will be assigned to this project and include their specific responsibilities.
- 4.6. Any other information you feel should be considered in the selection process.

5. Pricing

- 5.1. Minimum Services: PPLD is looking for the best-value proposal that meets the needs of the district to include all cost aspects of service. Please include:
 - 5.1.1. Lump Sum and unit costs, to include but not limited to travel, accommodations, reimbursables, and plan completion.
 - 5.1.2. A complete concrete Rehabilitation cost breakdown.

ADDENDUM A - PROPOSAL COVER SHEET

I. GENERAL INFORMATION

1. CONTRACTOR NAME _____

2. ADDRESS _____

3. PHONE _____

5. E-MAIL AND WEBSITE _____

6. CONTACT _____

II. STATEMENT OF MINIMUM QUALIFICATION

I, _____ (printed name) hereby declare

that I am the _____ (title) of

_____ (name of Contractor) submitting this profile and declaration, and that I am duly authorized to sign this profile and declaration on behalf of the above named Contractor. All information set forth in this profile and declaration and all attachments hereto are, to the best of my knowledge, true, accurate, and complete as of the submission date.

The signer further certifies that (please initial):

- a. _____ The Contractor has carefully examined all instructions, requirements, specifications, and terms and conditions of the RFP for which this proposal is submitted. The Contractor understands all instructions, requirements, specifications, and terms and conditions of this RFP, and hereby offers and proposes to furnish the goods and services described herein at the prices, fees, and/or rates identified in this proposal, in accordance with the instructions, requirements, specifications, and terms and conditions of this RFP.
- b. _____ This proposal is a valid and irrevocable offer that will not be revoked and shall remain open for the PPLD's acceptance for a period of ninety (90) calendar days from the proposal due date.
- c. _____ The Contractor is in full compliance with all applicable federal, state, and local laws, rules, regulations, and ordinances governing business practices.
- d. _____ All statements, information, and representations prepared and submitted in this proposal are current, complete, true, and accurate.

- e. _____ Submission of this proposal indicates the signer’s acceptance of the evaluation technique and that some subjective judgments may be made by PPLD as part of the evaluation.
- f. _____ The Contractor has to provide proof of all required insurance coverage.
- g. _____ A list of exceptions and deviations (if any) is attached.
- h. _____ There have been no claims, litigation, or other issues filed or pending against our Contractor in the past 5 years except as listed below.

- i. _____ The Contractor is aware of Colorado’s Immigration / illegal alien laws pertaining to public contracts. Addendum C (Colorado Statutes 8-17.5 – 102) is signed and attached.

Authorized Signature

Date

ADDENDUM B - CHECKLIST, QUESTIONNAIRE, AND PRICING FORM

QUALIFICATIONS (Fill in or attach additional pages as needed):

A. SIZE and AGE of Contractor _____

B. CONTRACTOR'S EXPERIENCE:

1. Qualifications:

1.1. List location, owner, and completion date of at least three (3) projects with similar scope.

Company Name: _____ Contact Name: _____
Address: _____ Phone: _____
Scope of service performed: _____

Company Name: _____ Contact Name: _____
Address: _____ Phone: _____
Scope of service performed: _____

Company Name: _____ Contact Name: _____
Address: _____ Phone: _____
Scope of service performed: _____

2. Pricing

Provide **lump sum** and **hourly rate** information as requested. All costs stated shall be "complete" costs to include travel, accommodations, reimbursables and plan completion, OH&P, applicable taxes, permits as required.

Project Cost: _____

Hourly Rates: Provide list with proposal package.

3. Projected start date and duration of installation:

Indicate your projected scheduling of this work with milestones.

Anticipated Start Date: _____ **Anticipated Completion Date:** _____

4. Indicate Preferred payment schedule:

Submittal of this bid form implies that the Contractor can adequately staff and schedule all work at the required time and has the resources available to procure all required materials at the required time. All costs indicated shall be maintained by the Contractor for not less than 30 days from the submittal date and shall be maintained throughout the duration of the contract after award.

ADDENDUM C - IMMIGRATION CLAUSE FOR CONTRACTS

Pursuant to Colorado Revised Statutes Section 8-17.5-102, the Pikes Peak Library District (“PPLD”) shall not enter into or renew a public contract for services with a contractor who knowingly employs or contracts with an illegal alien to perform work under the contract or who knowingly contracts with a sub-contractor who knowingly employs or contracts with an illegal alien to perform work under the contract.

Accordingly, Contractor agrees that it shall not:
Knowingly employ or contract with an illegal alien to perform work under this Agreement; or
Enter into a contract with a sub-contractor for work under this Agreement that fails to certify to the Contractor that the sub-contractor shall not knowingly employ or contract with an illegal alien to perform work under this Agreement.

Further, Contractor agrees that it shall comply with the following:
Contractor has the employment eligibility for all employees who are newly hired for employment to perform work under this Agreement through participation in either the e-verify program administered jointly by the U.S. Department of Homeland Security and the Social Security Administration (the “E-Verify Program”) or the department program administered by the Colorado Department of Labor and Employment (the “Department Program”).

Contractor shall not use the E-Verify Program or the Department Program procedures to undertake pre-employment screening of job applicants while the services under this Agreement are being performed.
Should Contractor obtain actual knowledge that a sub-contractor performing work under this Agreement knowingly employs or contracts with an illegal alien, the Contractor shall:
Notify the sub-contractor and PPLD within three days that Contractor has actual knowledge that the subcontractor is employing or contracting with an illegal alien; and

Terminate the sub-contract with the sub-contractor if, within three days of receiving the notice, the subcontractor does not stop employing or contracting with the illegal alien; except that Contractor shall not terminate the contract with the subcontractor if, during such three days, the sub-contractor provides information to establish that the sub-contractor has not knowingly employed or contracted with an illegal alien.

Contractor shall comply with any reasonable request by the Colorado Department of Labor and Employment (the “Department”) made in the course of an investigation that the Department may undertake pursuant to its authority under Colorado Revised Statutes Section 8-17.5-102(5).

Authorized Signature

Date

**Pikes Peak Library Asphalt and
Concrete Rehabilitation**

ITEM NO.	DESCRIPTION	QUANT.	UNIT	UNIT PRICE	COST
202	REMOVAL OF ASPHALT MAT (5" FULL DEPTH) <i>(Mill 4" - 5" of asphalt and 0" - 1" of base course)</i>	12188	SY		
202	REMOVAL OF EXISTING AREA DRAIN	1	LS		
202	REMOVAL OF CONCRETE CURB AND GUTTER	475	LF		
304	AGGREGATE BASE COURSE (CLASS 6) (CIP) <i>(Includes the removal of clay and/or unstable subgrade)</i>	100	TON		
403	HMA (GRADING S) (75) (58-28 or 64-22) (HAUL AND ASPHALT) <i>(3" bottom lift)</i>	2145	TON		
403	HMA (GRADING SX) (75) (58-28 or 64-22) (HAUL AND ASPHALT) <i>(2" top lift)</i>	1445	TON		
605	AREA DRAIN (6") <i>(Z535 or equivalent, raise 3" from existing grade)</i>	1	LS		
609	6" CONCRETE CURB AND GUTTER - TYPE 2 (SECTION - IIB)	475	LF		
627	PAVEMENT MARKING PAINT <i>(Match existing ADA layout and striping)</i>	1	EA		

TOTAL ESTIMATE _____

Pikes Peak Library GPR Pavement Thickness (in)

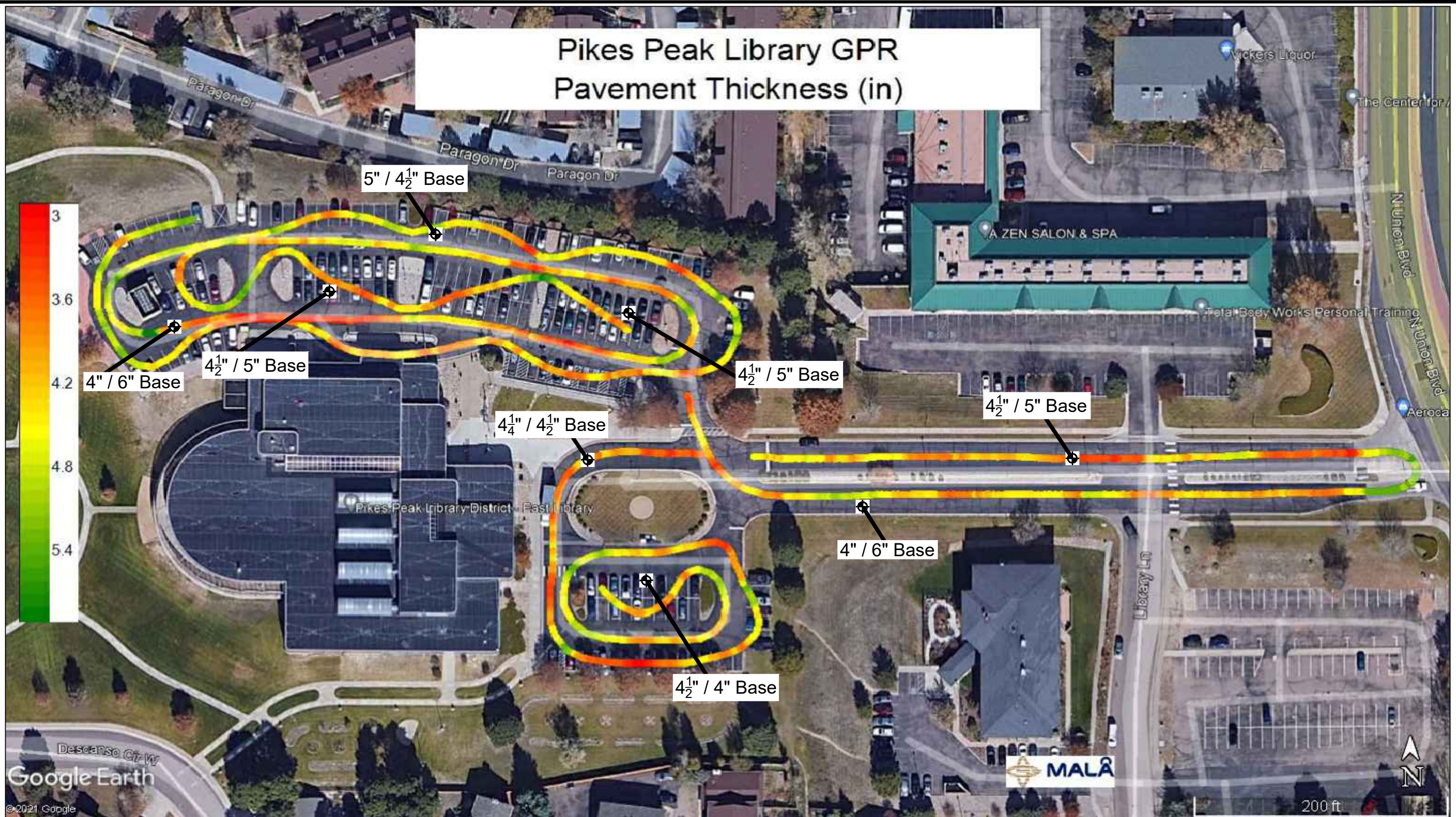

GOOGLE EARTH AERIAL IMAGE (DATE UNKNOWN)

◆ Indicates Asphalt / Base Thickness & Approximate Location.

North arrow pointing up.
(Not to Scale)

GROUND ENGINEERING CONSULTANTS	
GPR / CORING RESULTS	
JOB NO.: 21-3623	FIGURE: 1
CADFILE NAME: 3623SITE.DWG	

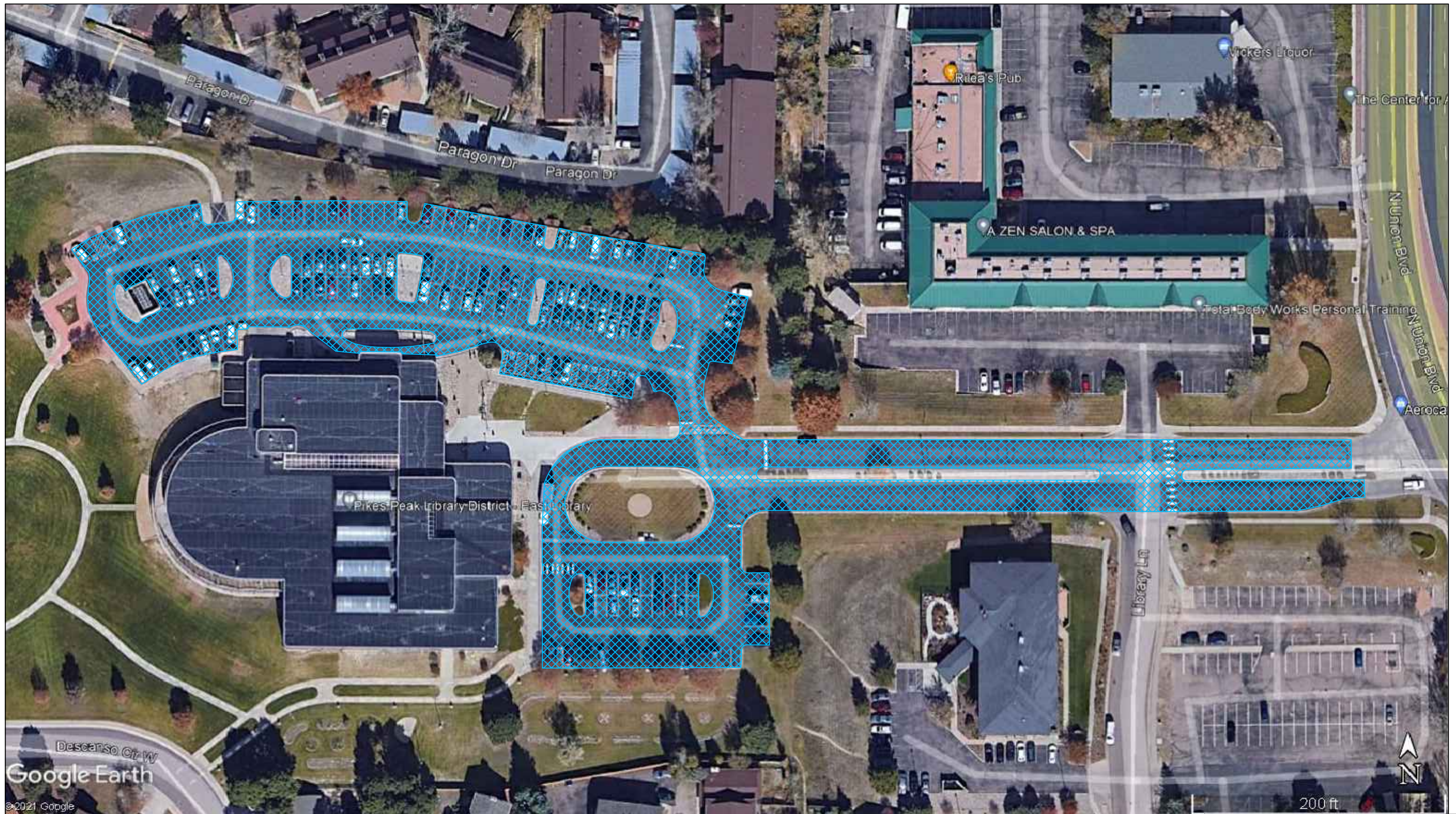

GOOGLE EARTH AERIAL IMAGE (DATE UNKNOWN)



Mill 5" (4"-5" of Asphalt & 0" to 1" of Base Course) & Replace with 3" (S) Mix & 2" (SX) Mix.

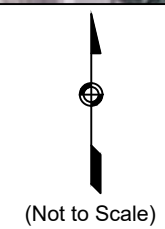

GROUND ENGINEERING CONSULTANTS	
SCOPE OF WORK	
JOB NO.: 21-3623	FIGURE: 2
CADFILE NAME: 3623SITE.DWG	

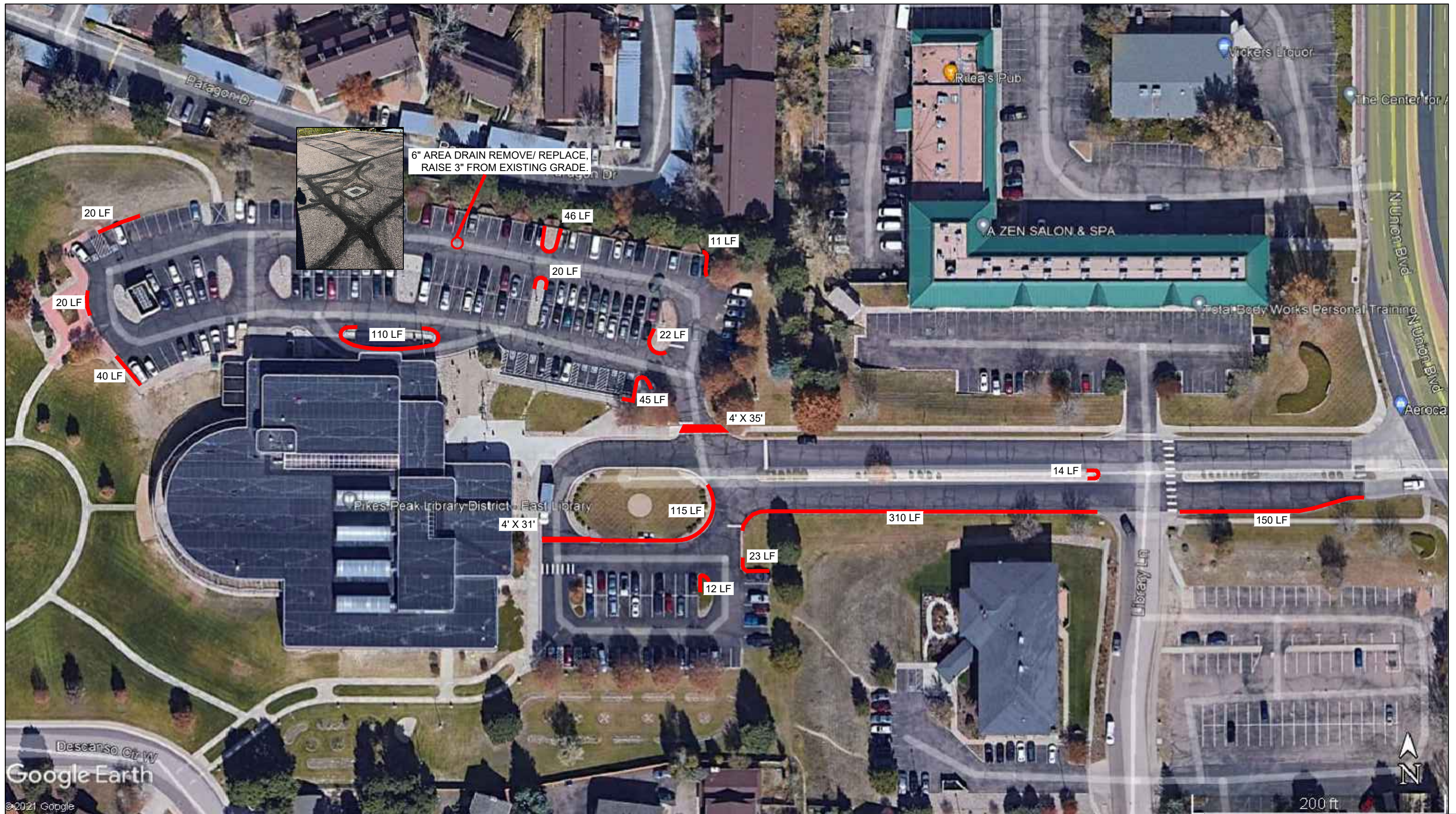

GOOGLE EARTH AERIAL IMAGE (DATE UNKNOWN)

Remove & Replace Curb & Gutter Remove & Replace Concrete Pavement.

(Not to Scale)

GROUND ENGINEERING CONSULTANTS	
SCOPE OF WORK	
JOB NO.: 21-3623	FIGURE: 3
CADFILE NAME: 3623SITE.DWG	



GOOGLE EARTH AERIAL IMAGE (DATE UNKNOWN)

PHASE 1

PHASE 2

PHASE 3

PHASE 4

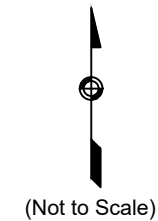

GROUND ENGINEERING CONSULTANTS	
PHASING PLAN	
JOB NO.: 21-3623	FIGURE: 4
CADFILE NAME: 3623SITE.DWG	

General

1. This work shall include all equipment, labor, services, skills, materials, supplies, tools, etc. necessary or required to produce the finished results described herein.
2. The cost for removing and resetting the parking blocks shall be included with all other bid items.
3. The cost for traffic control lane shifts during Phase 2 and Phase 3 shall be included with all other bid items.
4. All work shall be done to *Pikes Peak Regional Transportation Authority Standards*, unless modified herein.
5. All cleaning of materials or washing of concrete (including of trucks) or asphalt equipment shall be done off-site, if possible. Cleaning on site shall be in accordance with *Pikes Peak Regional Transportation Authority environmental standards*.
6. The location of the work is as shown on the maps and explanatory materials furnished by the District.
7. The contractor may request an interruption of the library sprinkler system. The length shall not exceed 48 hours and must be requested 24 hours in advance of the interruption.
8. Payment to the Contractor will be within 30 days of acceptance and completion of the work.
9. The Contractor must furnish a current general liability certificate showing Workers Compensation coverage that would hold the Pikes Peak Library District harmless in case of worker's injury.
10. The Contractor must familiarize himself fully with the furnished bid materials. Failure to do so will not relieve a successful bidder of his obligation to furnish all material and labor necessary to carry out the provisions of this Contract.
11. The Contractor's attention is drawn to the existence of light posts, sign posts, fences, benches, and retaining walls that may affect clearance and restrict the working area. The Contractor shall do the work without damaging District items. Any damage of existing items (including damage of sod) shall be repaired at Contractor's expense.
12. Work shall continue on all consecutive weather permitting days until completion.
13. Work hours are limited to 7:00 AM - 7:00 PM Monday thru Saturday. Access to one designated public parking area must be maintained at all times.
14. Access to local businesses adjacent to the entry drives must be maintained at all times during construction. Any scheduled closures must be approved in advance by Pikes Peak Library District and the corresponding property manager.
15. All labor shall be performed in the best and most workmanlike manner by workers skilled in their respective trades. Any work showing lack of competence and/or first-class craftsmanship will be rejected.
16. Any work that is found not to meet the specifications of this document shall be redone or replaced at the Contractor's expense.
17. Contractor's equipment and work operation shall not cause unnecessary annoyance to the public. Worker's vehicles not directly necessary to the actual work should be parked off site whenever possible.
18. The Contractor is responsible for calling in utility locates prior to construction. It is not anticipated that any utility damage will be encountered, but the Contractor is responsible for making an independent evaluation.
19. No toilet facilities are available. The Contractor is responsible for any arrangements for his work crew.
20. Contractor will take precautions to avoid damage to public or private property during all stages of Contractor's work. Upon completion of work, Contractor shall restore the work site area to include paved surfaces, lawns, and any private or public property affected.
21. Tack coat, if placed by wand, should have coverage similar to a distributor truck. Asphalt lifts not placed on same day will require additional tack coat prior to subsequent lift placement.
22. Hot Mix Asphalt Pavement shall not contain more than 20 percent (20%) reclaimed asphalt pavement. The reclaimed asphalt pavement shall meet the requirements of section 703.04 (CDOT).
23. A rubber tire roller is a requirement for this project.
24. The blocking of tenant's access to their property should be avoided where possible. If access is to be blocked for one hour or more, the Contractor must notify affected tenants. It is anticipated that tenants will have access to sidewalks and gutter pans within 24 hours of the finishing of concrete.
25. Work sites shall be restored to an orderly condition with no loose debris and materials, and equipment neatly arranged at the end of the day.
26. All debris or removed material shall be disposed of off-site at the Contractor's expense. No removed material shall remain on site 24 hours after excavation.

Concrete

1. Concrete shall be CDOT Class B.
2. All sidewalk shall be 4-inch depth minimum. All valley gutter shall be 6-inch depth minimum. Marked areas may have settled or heaved, and minor leveling of the site should be anticipated.
3. All concrete marked for removal shall be deeply saw-cut before removal. Damage beyond the saw-cut shall require a new saw-cut. The replaced additional length shall be at the Contractor's expense.
4. If the excavated hole is not in line with the adjacent sidewalk/valley gutter, the contractor shall excavate to the proper alignment before forming and placing of concrete.
5. After removal, the bottom of the hole shall be tamped to ensure a flat, smooth surface. The depth shall then be checked and no point of the area to have concrete shall be less than the minimum depth stated above.
6. Vertical alignment must match the adjacent concrete. A consistent flow line shall be established and approved before concrete is placed.
7. It is anticipated that there may be some tree roots within the required depth of the concrete. Roots less than one-inch in diameter should be cut and removed. For roots greater than one inch in diameter, the Contractor shall remove soil under the root in an attempt to provide room to expand under the root.
8. New concrete shall be formed on soil/loose rock sides of the sites. The inspector may allow no forming adjacent to asphalt if the edge is uniformly straight and solid. Adjacent to retaining walls of any construction, a 1/8" neoprene or approved fibrous expansion material should be used to ensure that the wall and concrete will not affect the durability of each other.
9. All outside edges and transverse joints shall be rounded tool joints. Transverse joints shall receive additional depth by a trowel. The top finish shall be lightly broom-raked in the direction of water flow.
10. Length of sidewalk between transverse joints shall typically be five feet. Length of valley gutter shall typically be eight feet. Lengths may be adjusted to match adjacent lengths of sidewalk or gutter. No lengths shall exceed ten feet.
11. Any asphalt damage shall be patched and compacted with hot mix asphalt as part of the bid price.

GROUND
ENGINEERING CONSULTANTS

NOTES

JOB NO.: 21-3623

FIGURE: 5

CADFILE NAME: 3623SITE.DWG



Z535
HEAVY-DUTY PARKING STRUCTURE DRAIN

SPECIFICATION SHEET

TAG _____

Dimensional Data (inches and [mm]) are Subject to Manufacturing Tolerances and Change Without Notice

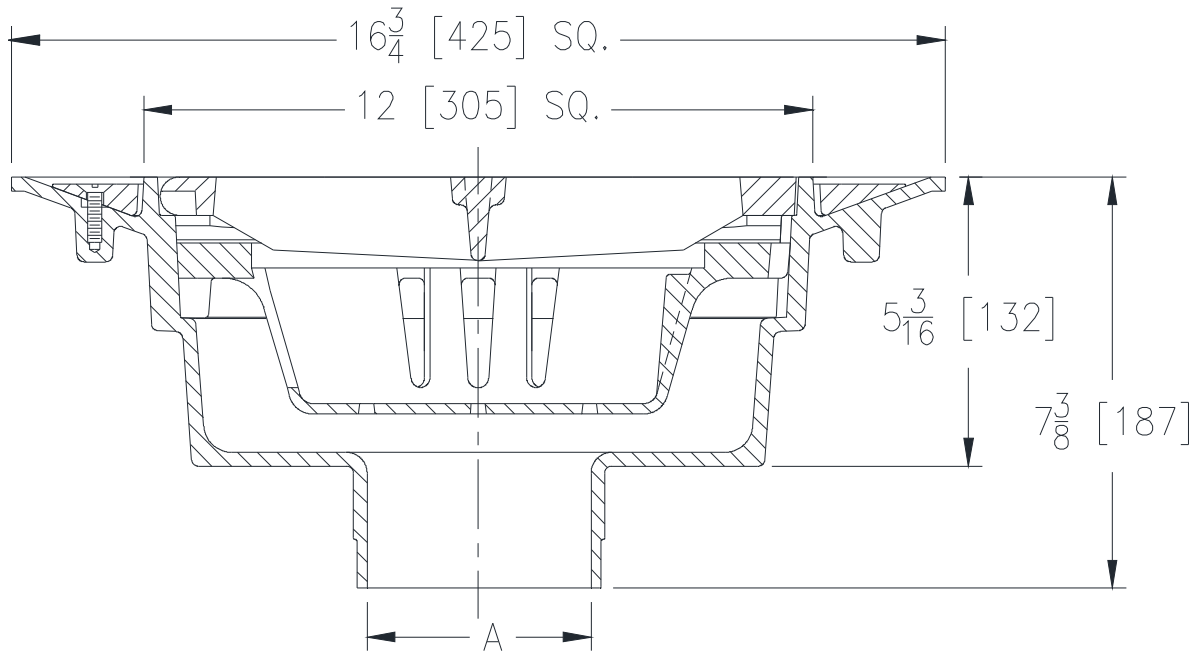

	A- Pipe Size In. [mm]	Approx. Wt. Lbs. [kg]	Grate Open Area Sq. In. [cm ²]
Aluminum	3, 4, 6, 8 [76, 102, 152, 203]	28 [13]	56 [361]
Cast Iron	3, 4, 6, 8 [76, 102, 152, 203]	75 [34]	56 [361]

ENGINEERING SPECIFICATION: ZURN Z535

Square top heavy-duty drain, oven cured acid resistant epoxy coated aluminum body with bottom outlet, top membrane clamping collar, anti-ponding slots, sediment bucket and heavy-duty anti-tilt hinged slotted grate with stainless steel hinge pins.

OPTIONS (Check/specify appropriate options)

PIPE SIZE

3, 4, 6, 8 [76, 102, 152, 203]

(Specify size) **OUTLET**

_____ NH No-Hub

PREFIXES

- ___ Z A.R.C. Aluminum Body and Top*
- ___ ZC D.C.C.I. Body and Top

SUFFIXES

- ___ -CI Cast Iron Grate (For ZA option only)
- ___ -L Locking Device

* Regularly furnished unless otherwise specified.